

[平面図]

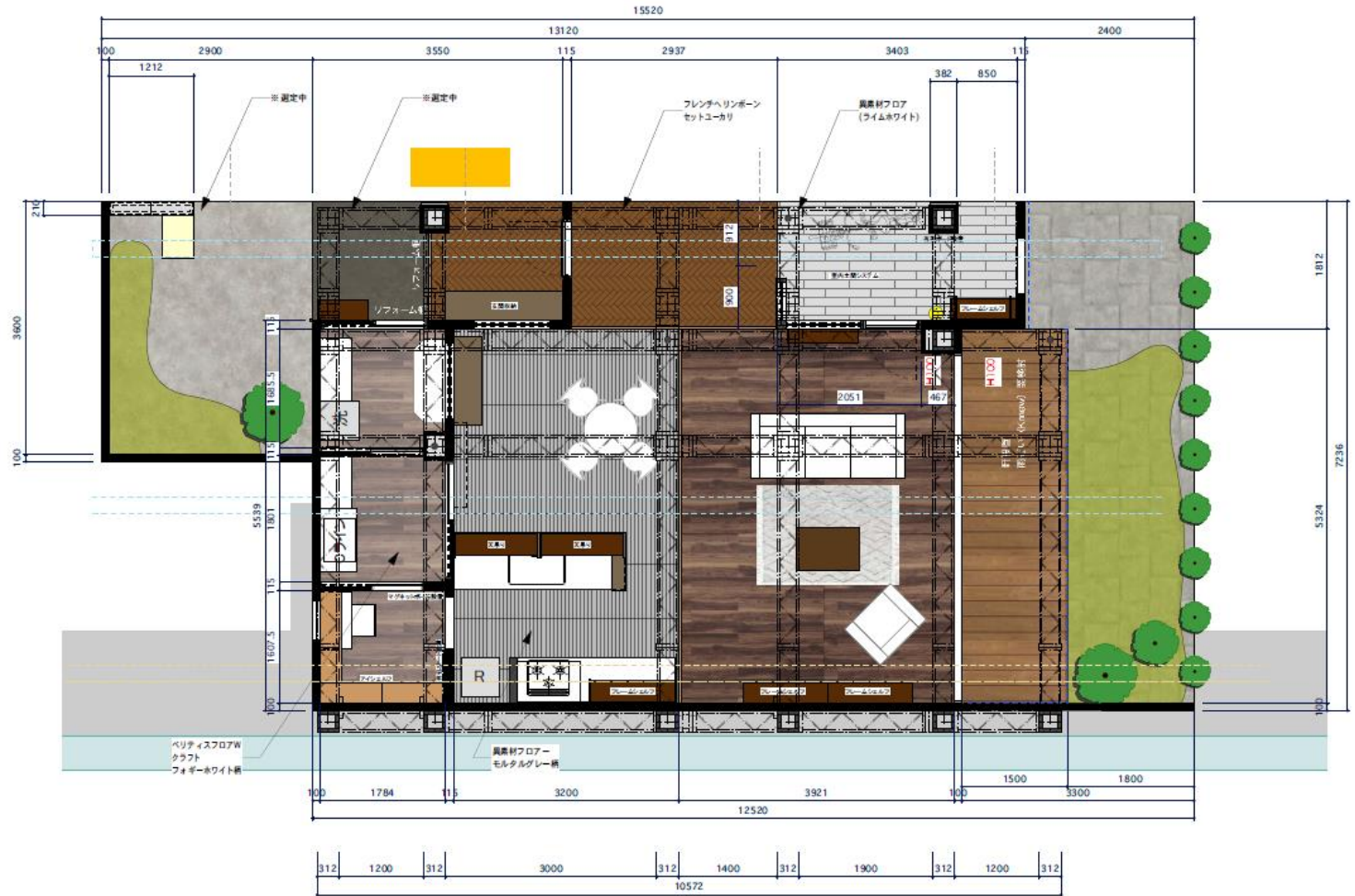

[壁面仕上げ平面図]

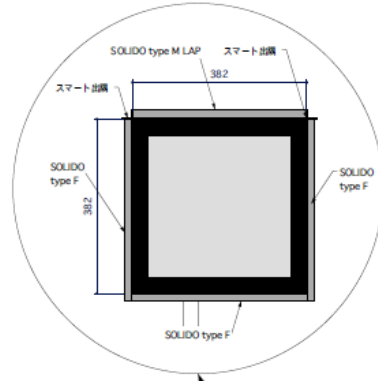

- | | |
|-------------------------------------------------------------|--------------------------------------|
| ① SOLIDO TypeM LAP | ⑦ クロス(ESPOIR NEW AGE MATE 69 659039) |
| ② SOLIDO TypeF(横貼) | ⑧ クロス(TH8775/サンゲツ) |
| ③ クロス(ESPOIR NEW AGE MATE 69659039) + 羽目板(グレイージュウォールナット) | ⑨ クロス(SP-9504) |
| ④ 腰部: 羽目板(ブラックオーク) | ⑩ クロス(FE-1041) |
| ⑤ 腰部: キッチンボード(黒) | ⑪ タイル |
| ⑥ 壁面: キッチンボード(黒) | ⑫ クロス(36205-3) |
| | ⑬ 壁面: 羽目板(ブラックオーク) |

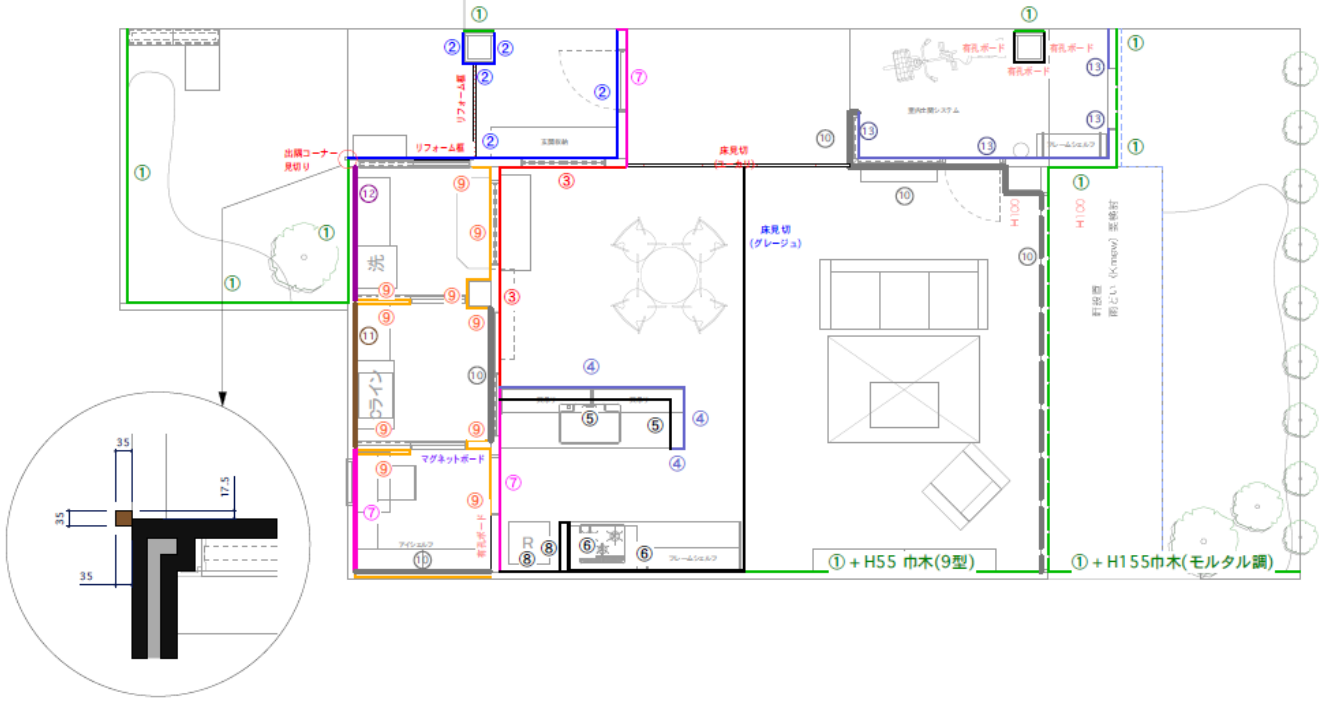

[巾木仕上げ平面図]

- A** 巾木9型(黒)
- B** 巾木9型(ソフトウォールナット柄)
- C** 巾木9型(しっくいホワイト柄)
- D** 羽目板 見切縁90(グレージュウォールナット柄)
- E** 羽目板 見切縁90(ブラックオーク柄)

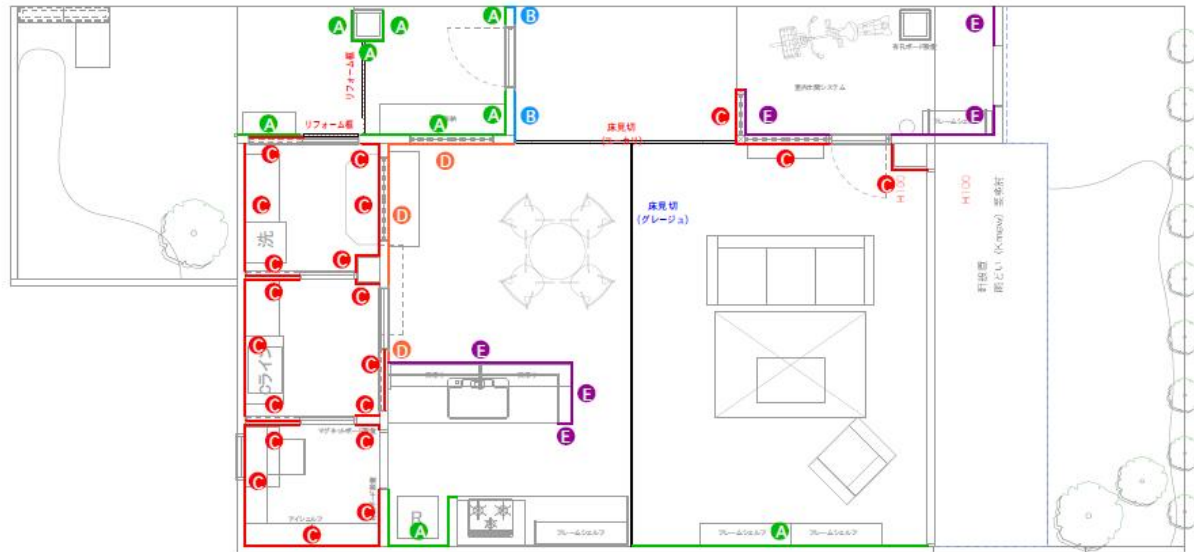

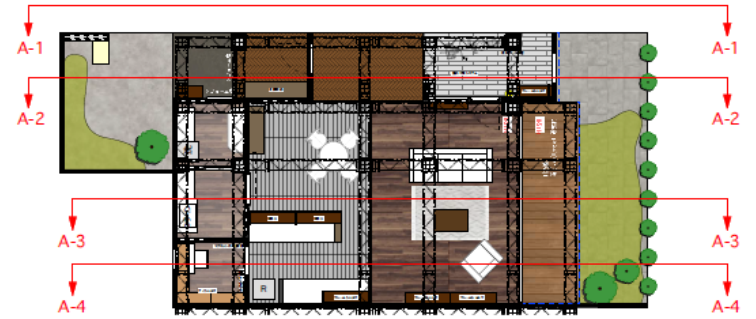

[A-1]

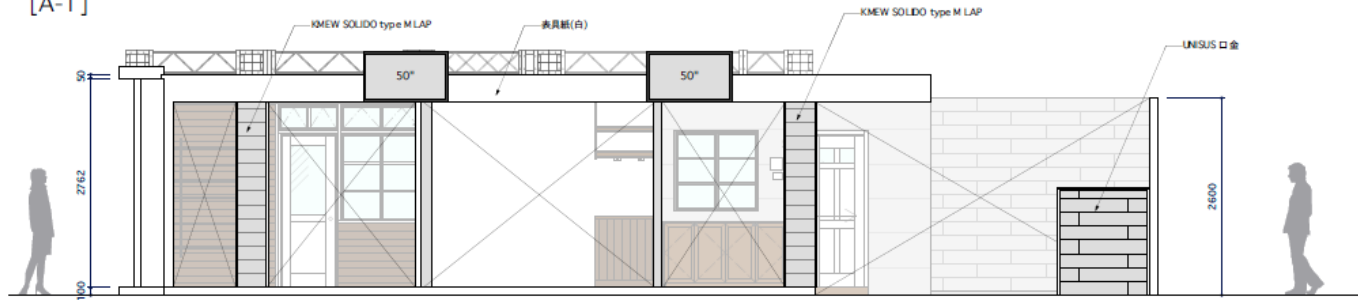

[A-2]

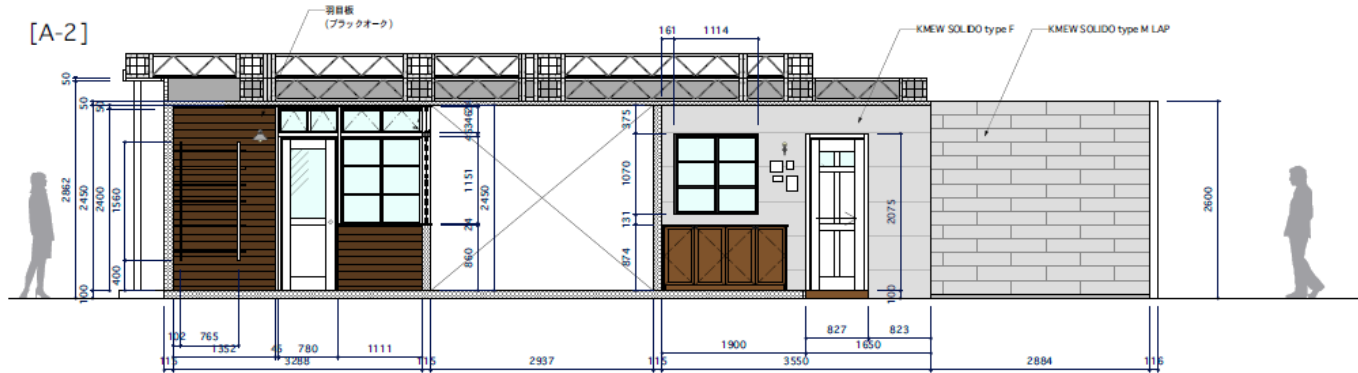

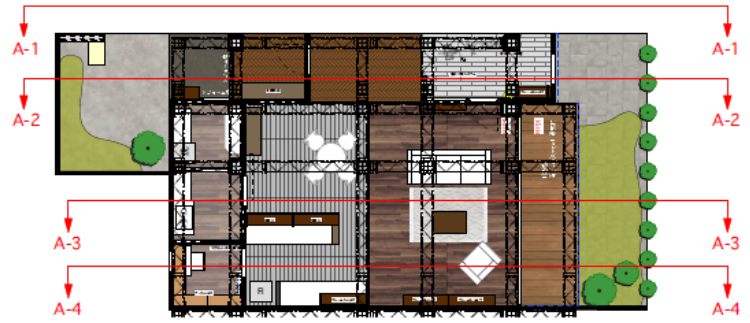

[A-3]

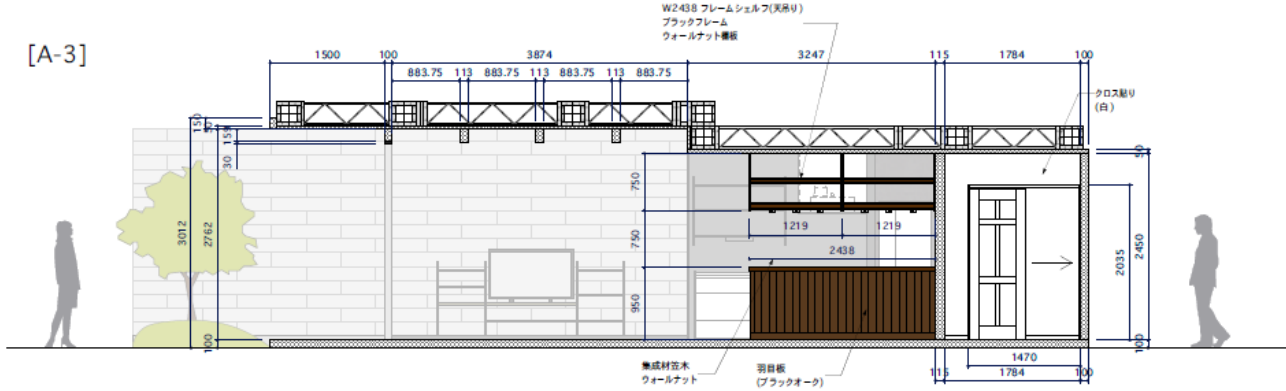

[A-4]

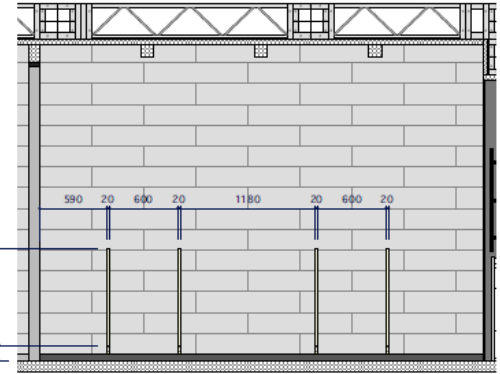
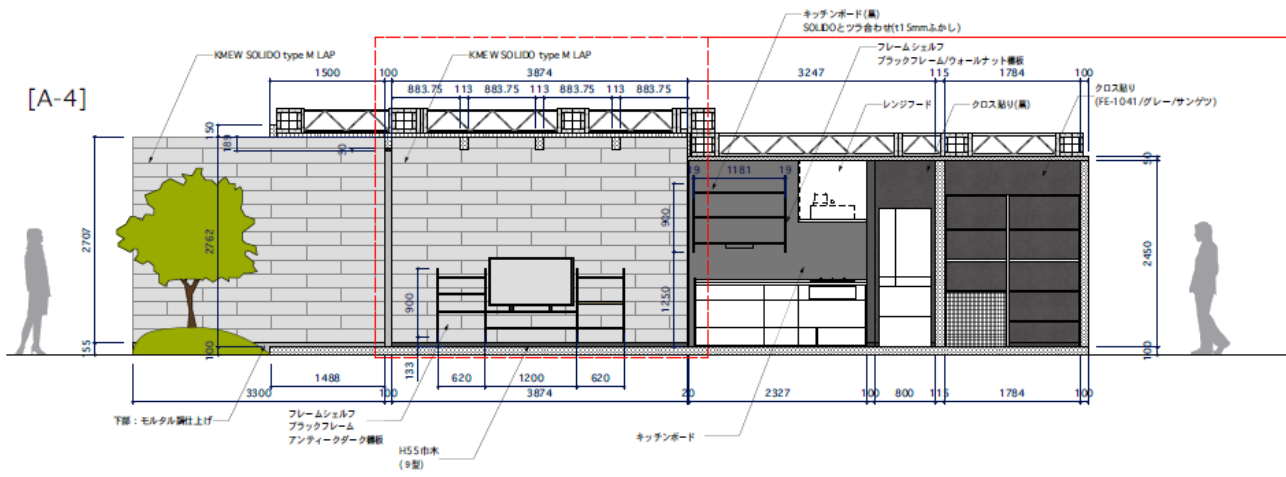

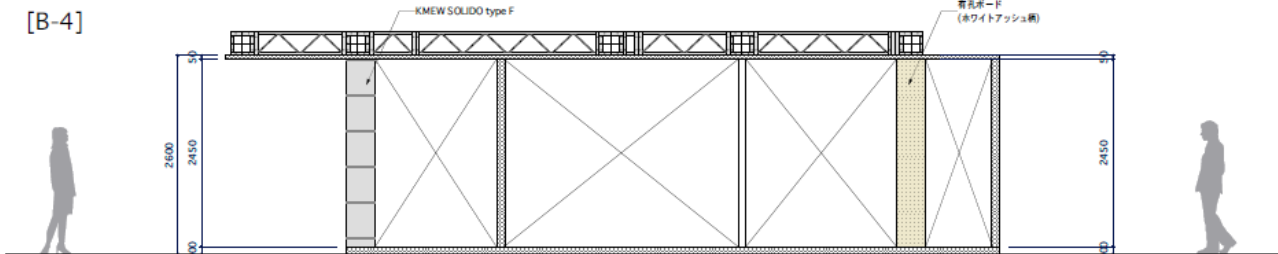
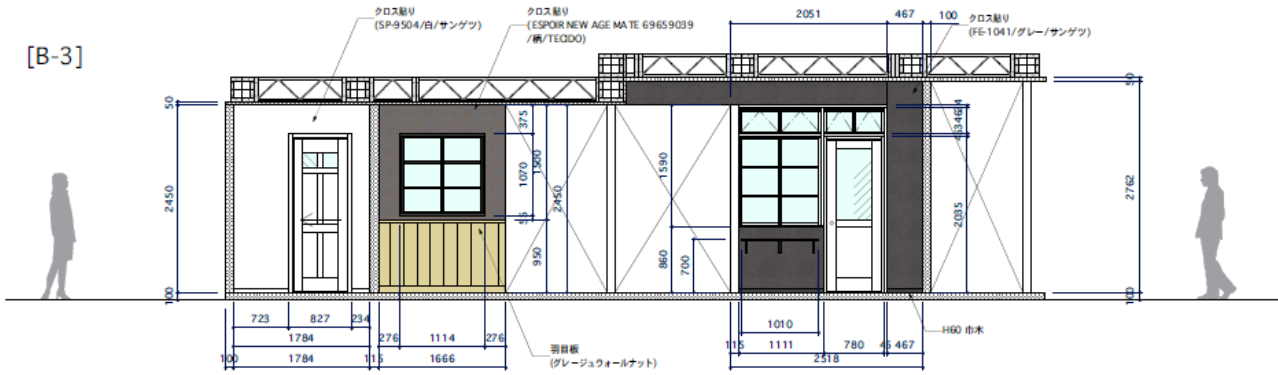
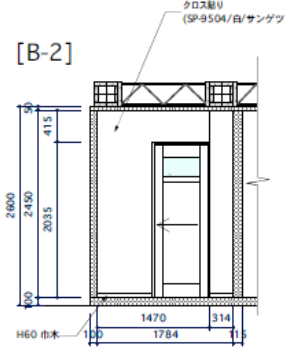
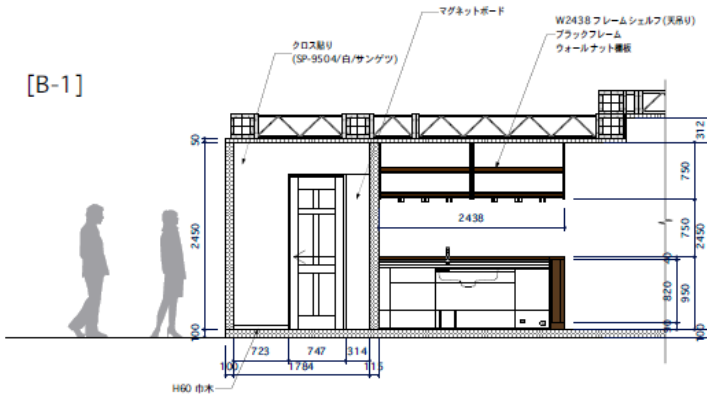

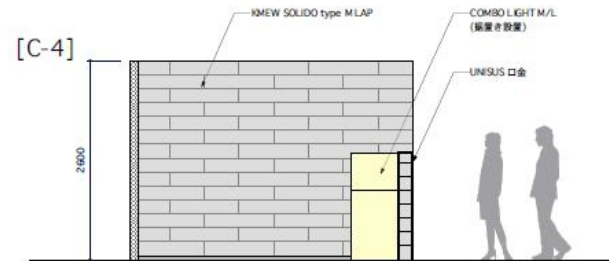
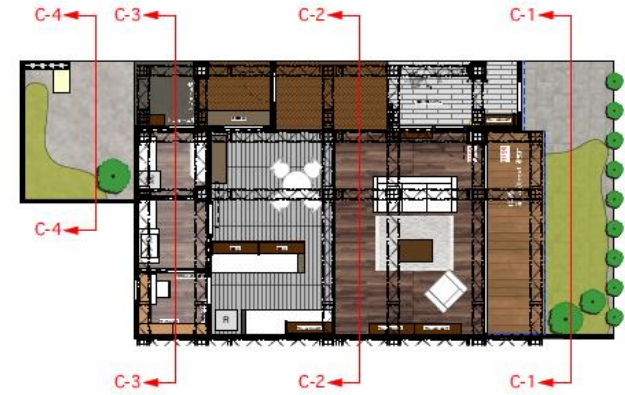
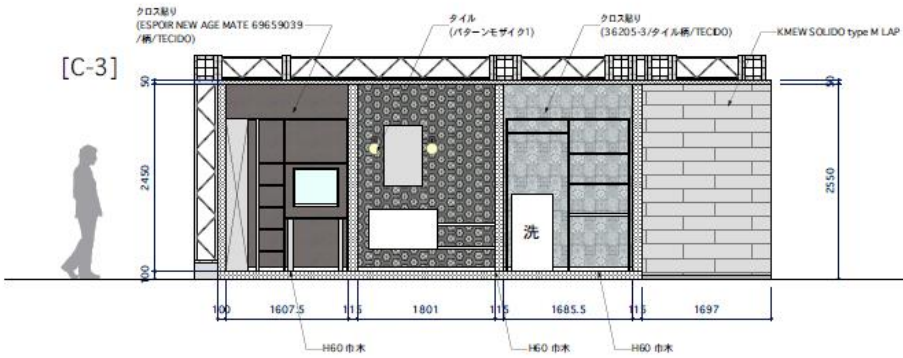
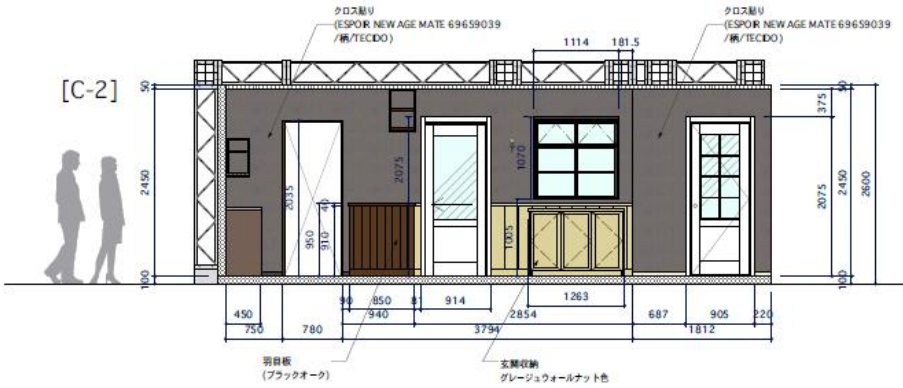
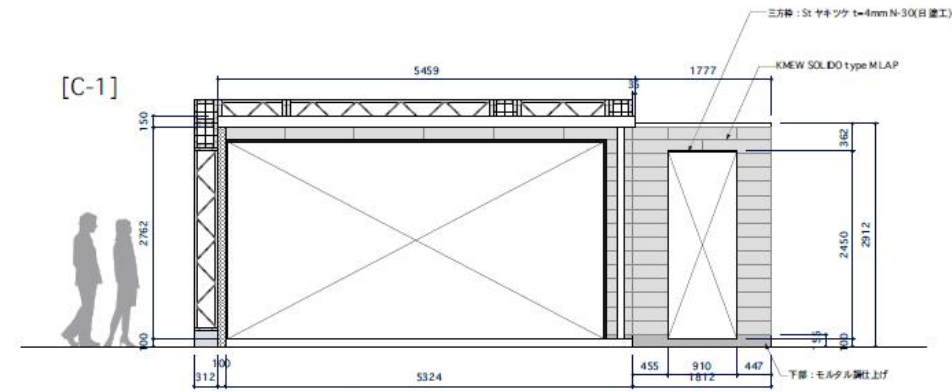

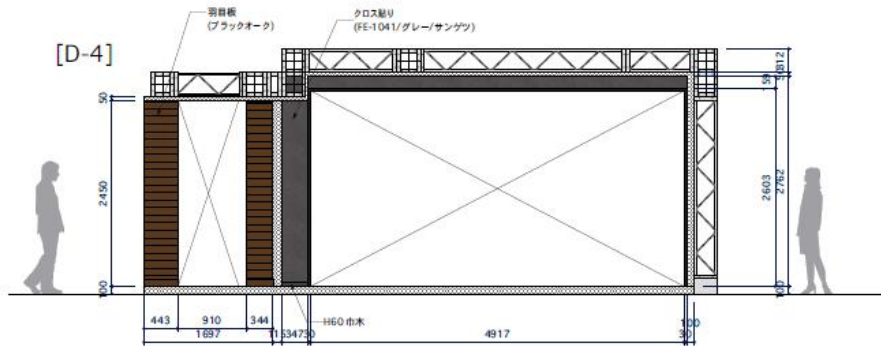
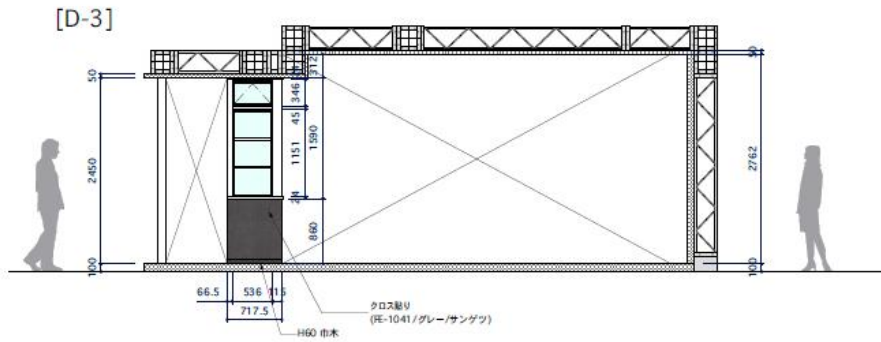
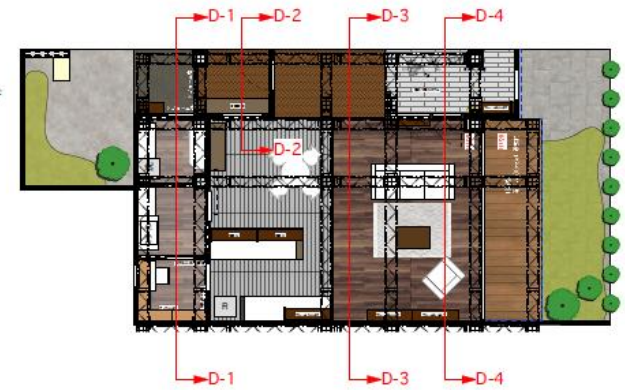
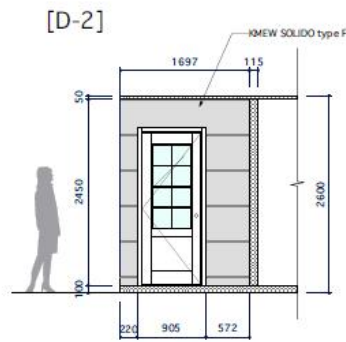
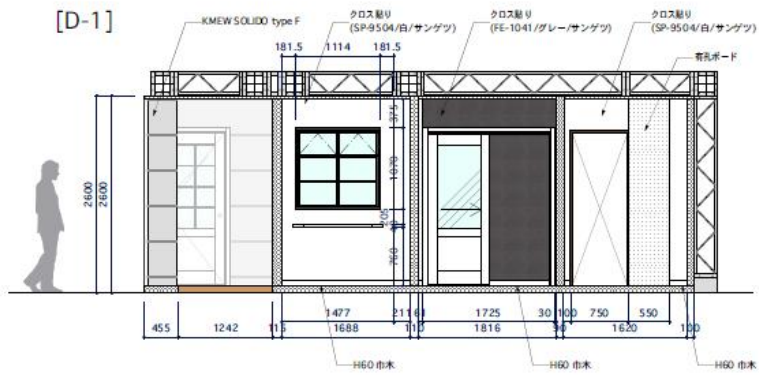

【平面図】

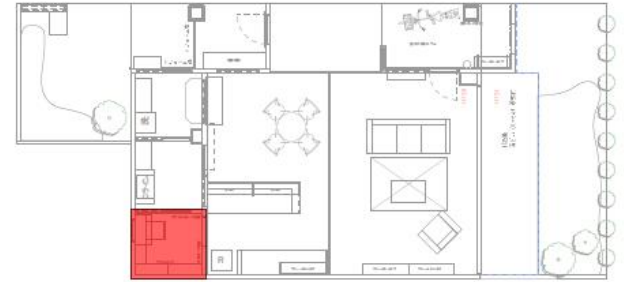
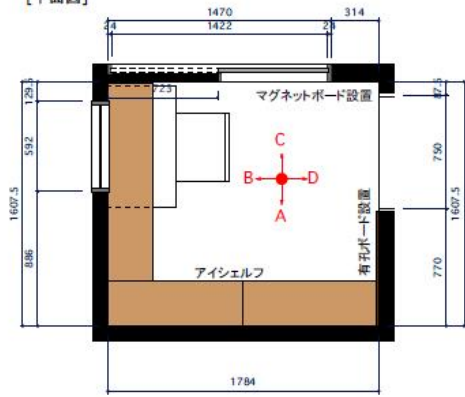

【展開図-A】

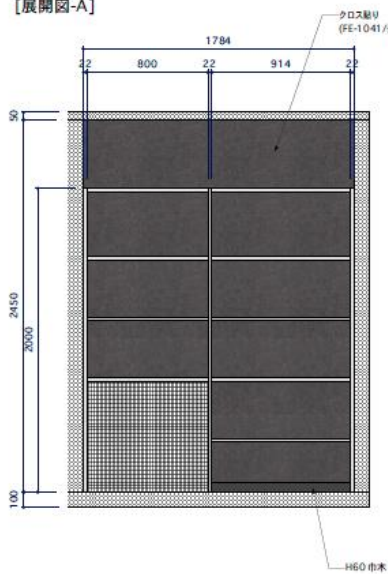

【展開図-B】

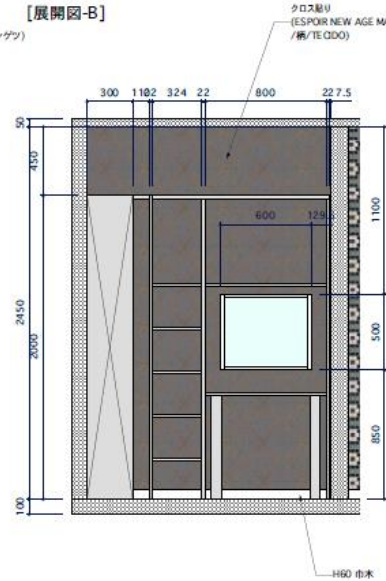

【展開図-C】

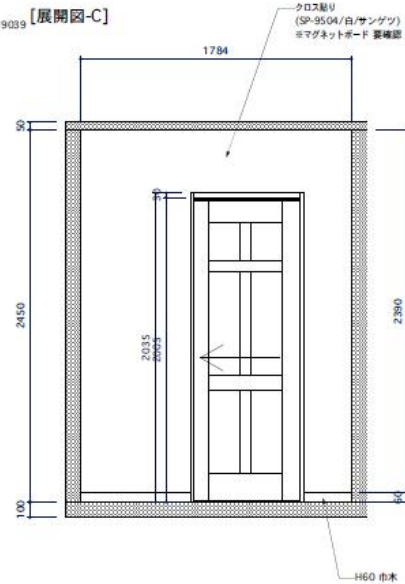

【展開図-D】

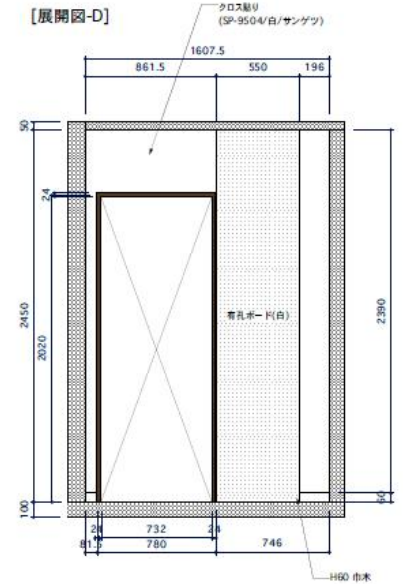

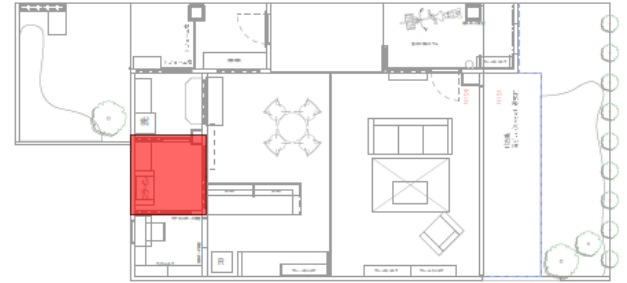
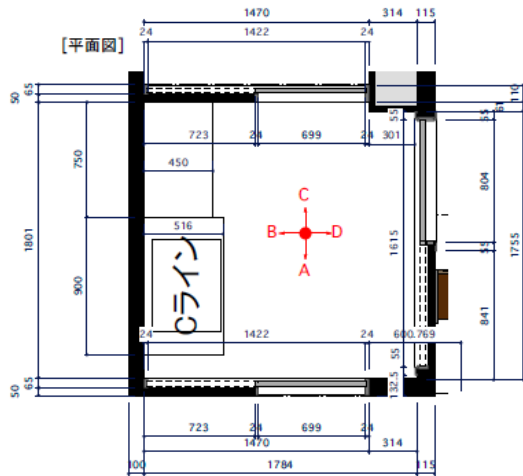

【展開図-A】

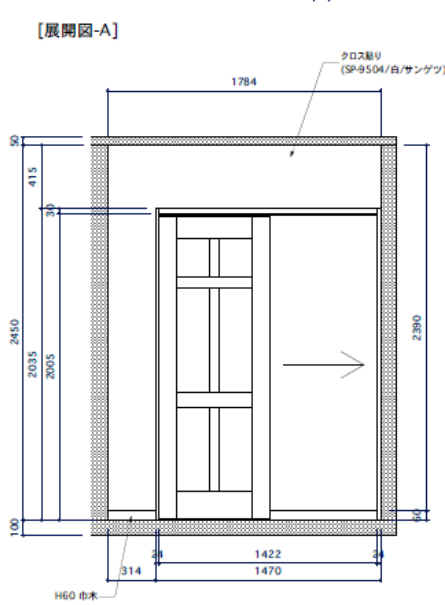

【展開図-B】

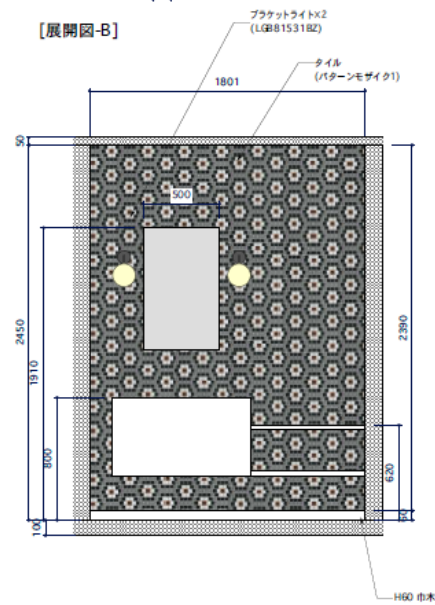

【展開図-C】

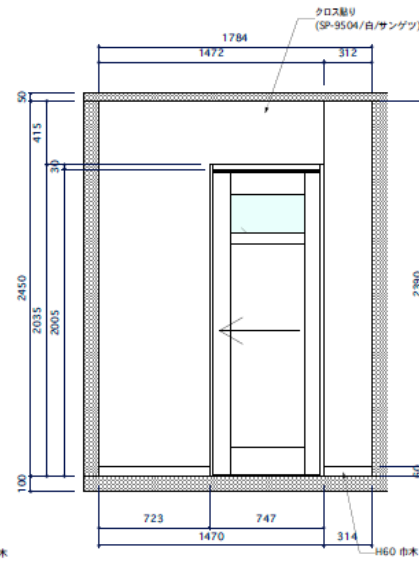

【展開図-D】

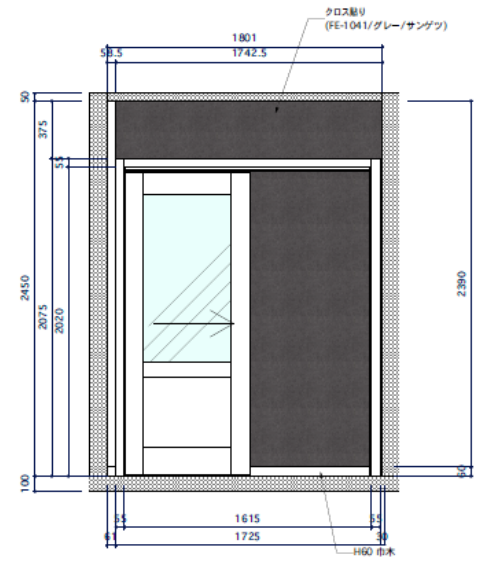

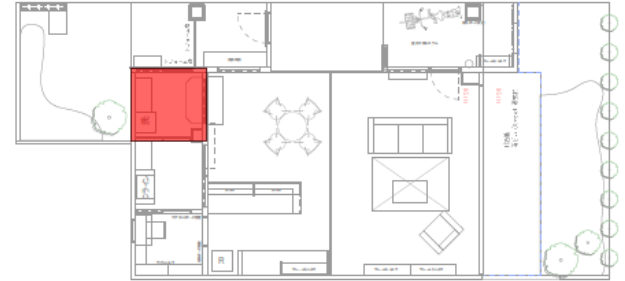
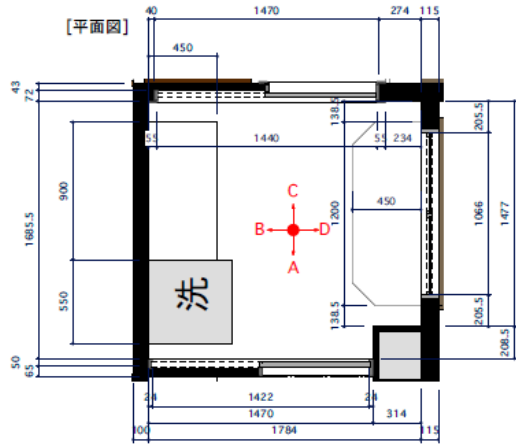

[展開図-A]

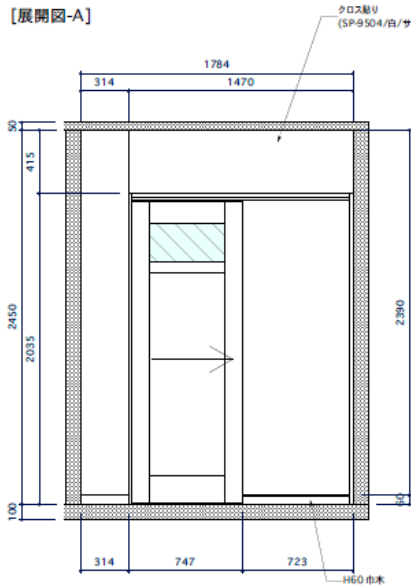

[展開図-B]

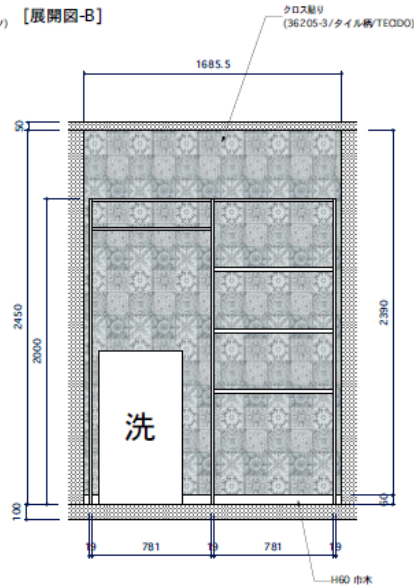

[展開図-C]

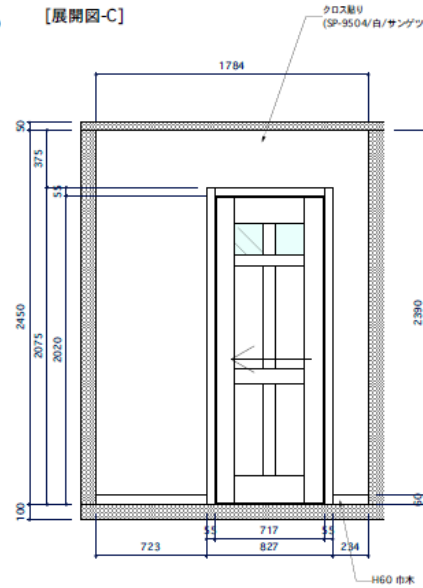

[展開図-D]

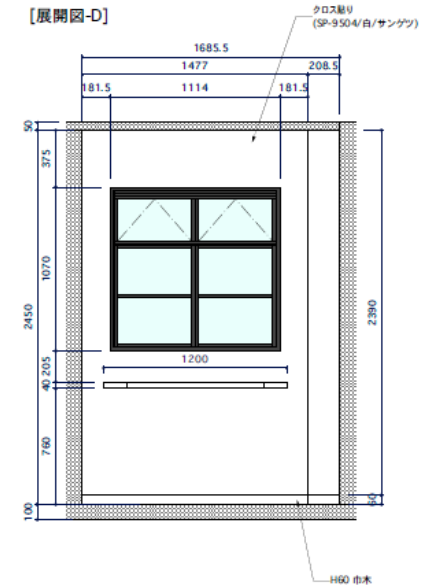

[立面図]
S=1/60

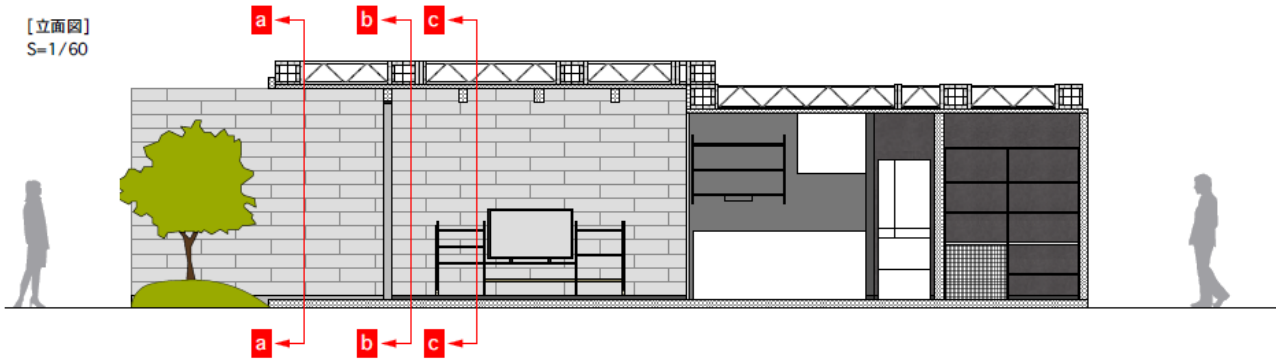

[断面図-c_フレーム設置部]
S=1/10

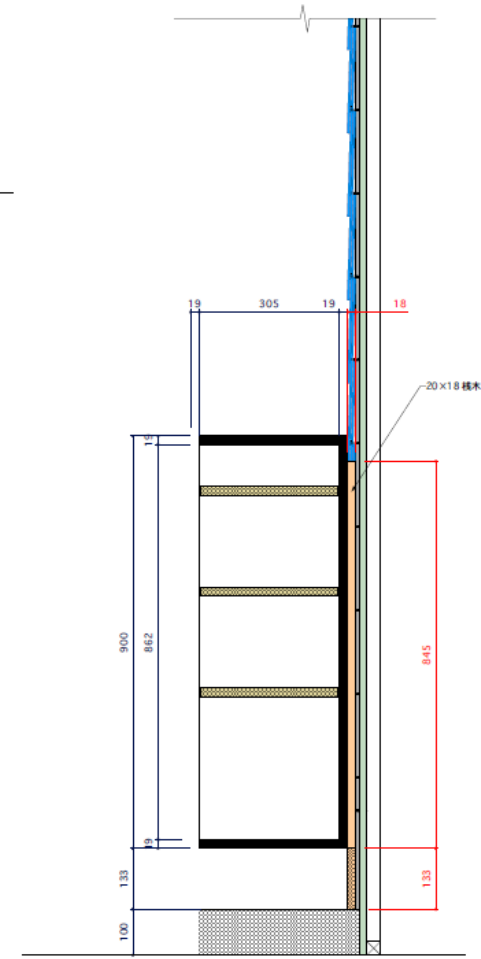

[断面図-c]
S=1/20

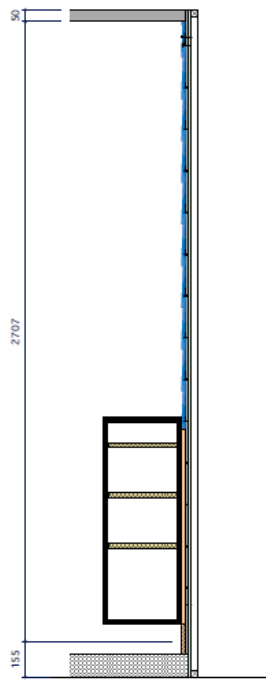

[断面図-c_上部]
S=1/5

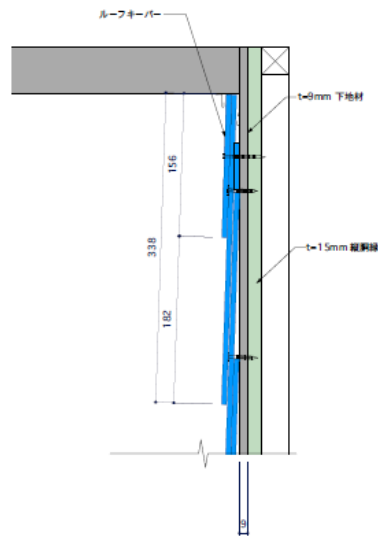

[断面図-c_下部]
S=1/5

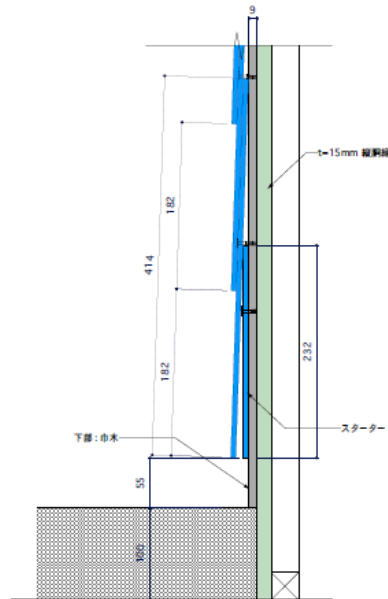

[平面図]

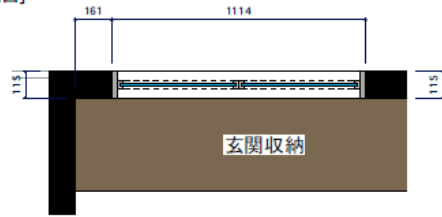

[平面詳細図]
S=1/10

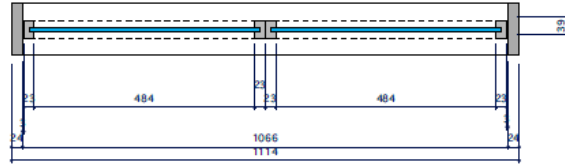

[正面図]

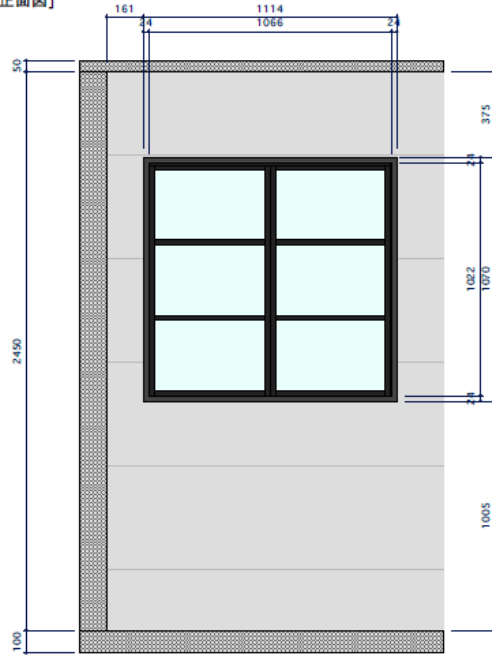

[断面図]

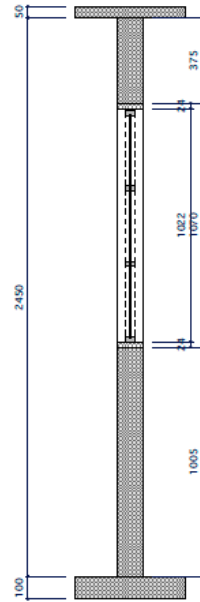

[断面詳細図]
S=1/10

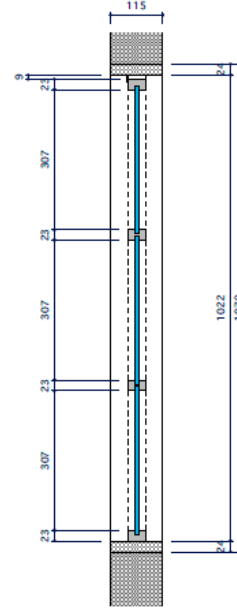

[平面図]

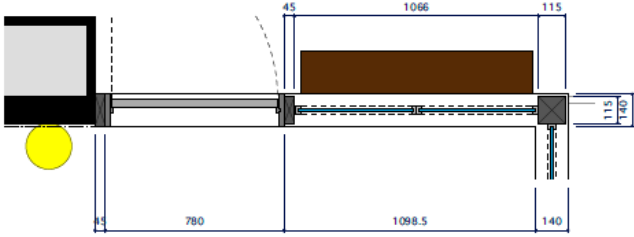

[平面詳細図]
S=1/10

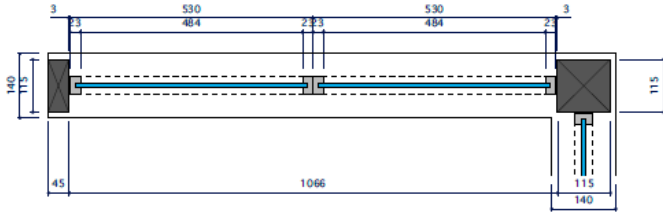

[正面図]



[断面図]

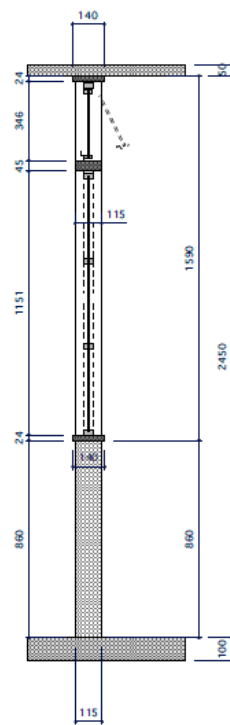

[断面詳細図]
S=1/10

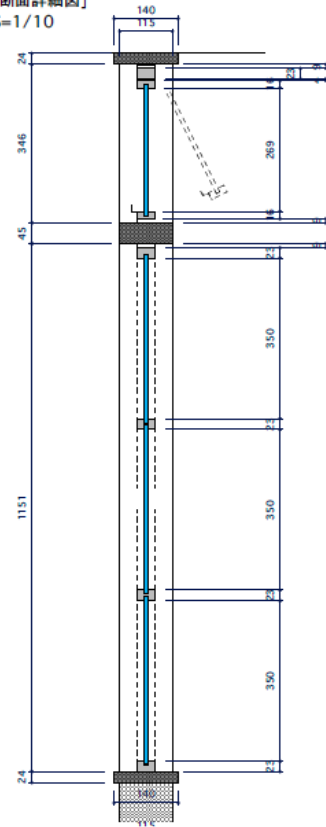

[平面図]

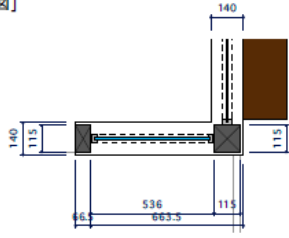

[平面詳細図]
S=1/10

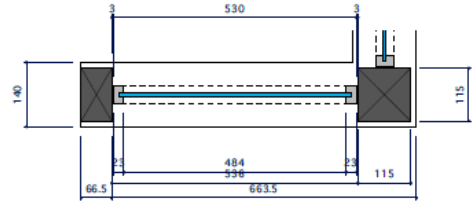

[正面図]

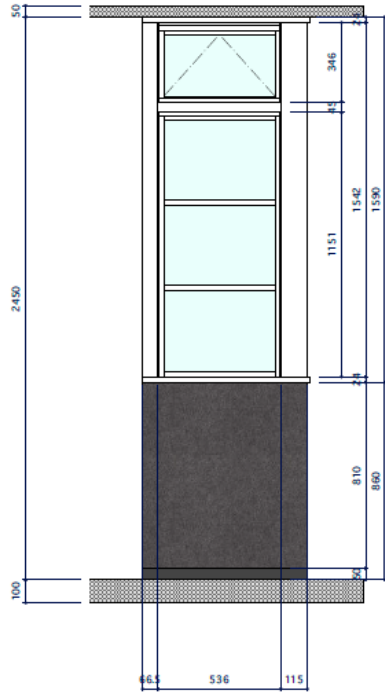

[断面図]

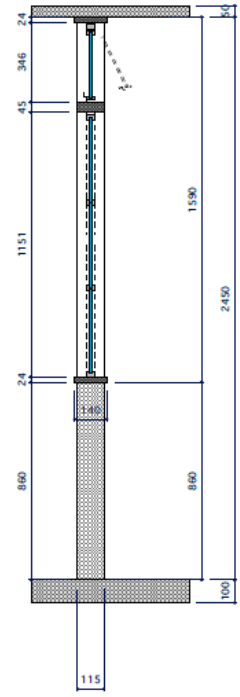

[断面詳細図]
S=1/10

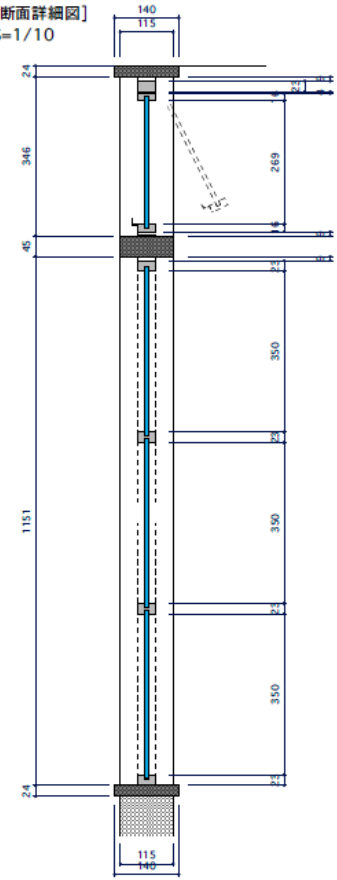

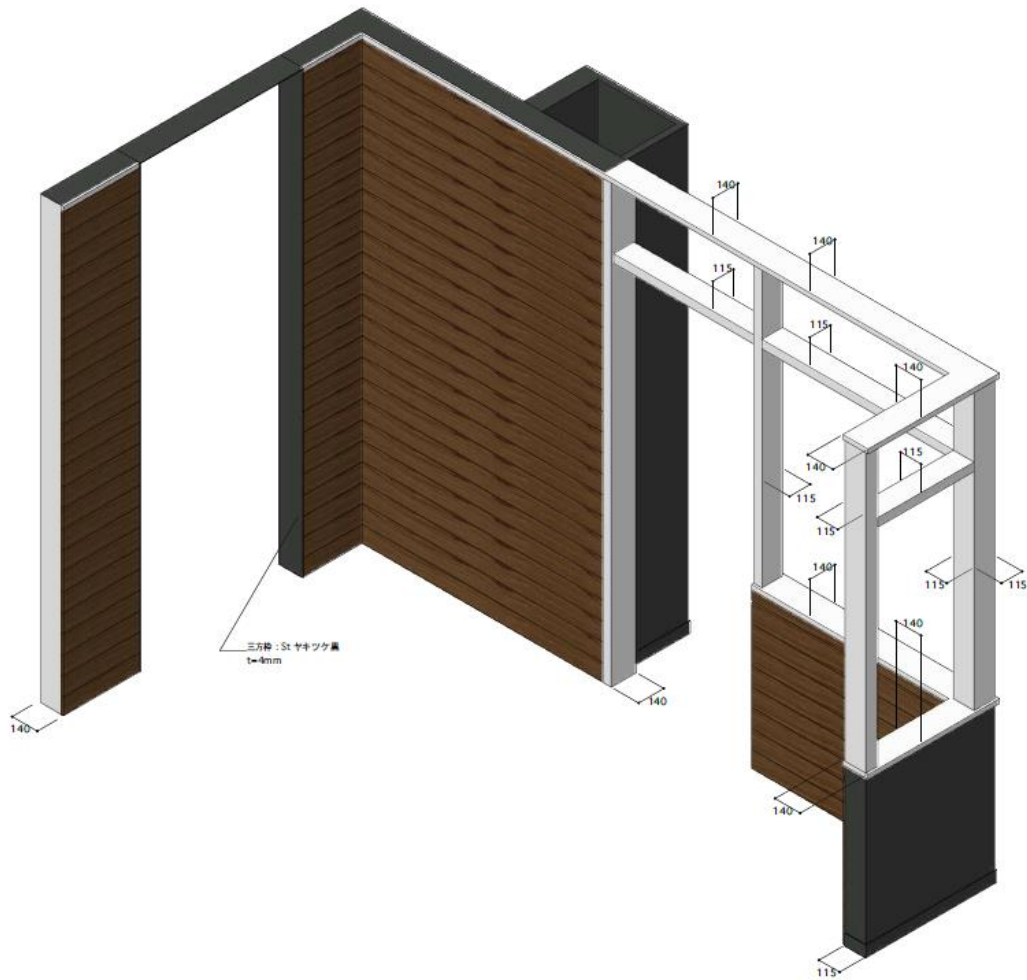
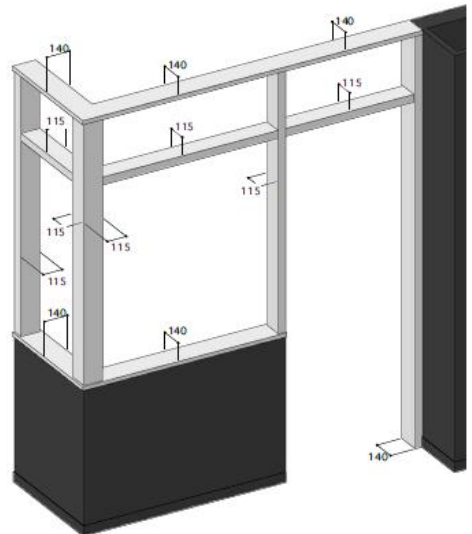
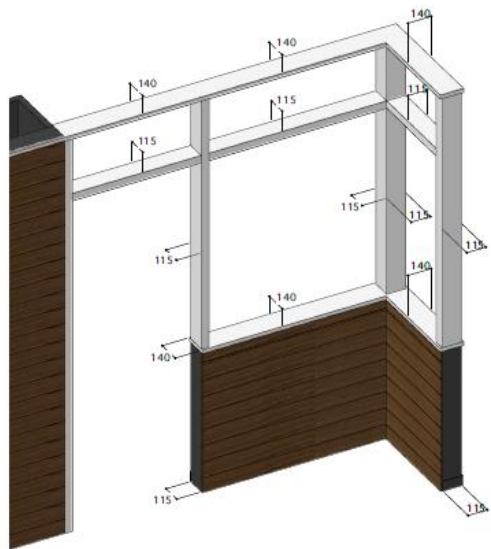

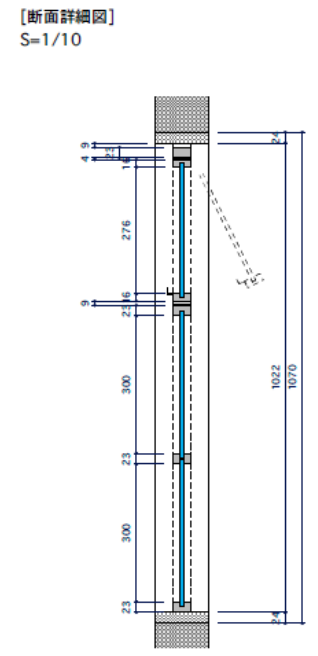
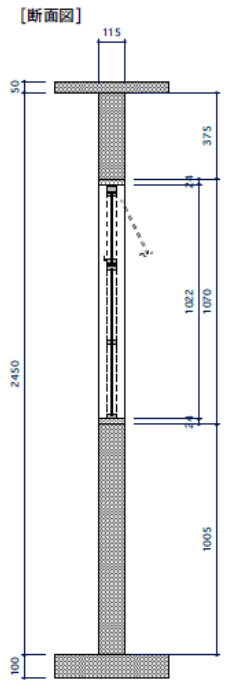
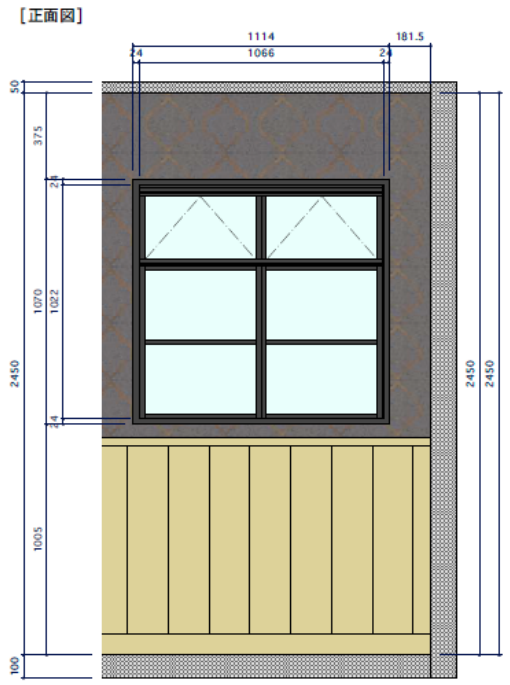
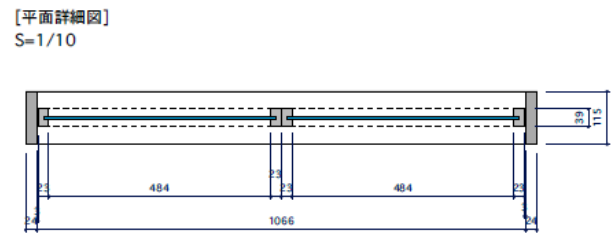
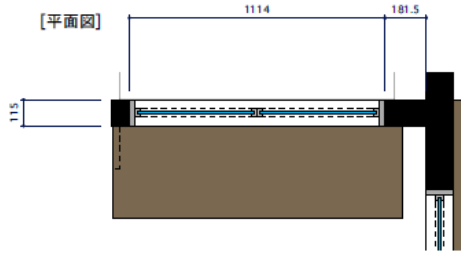

[平面図]

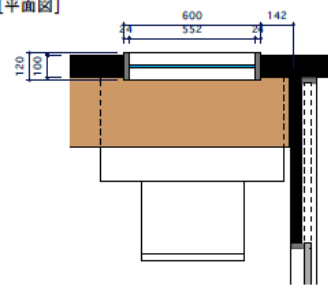

[平面詳細図]
S=1/10



[正面図]

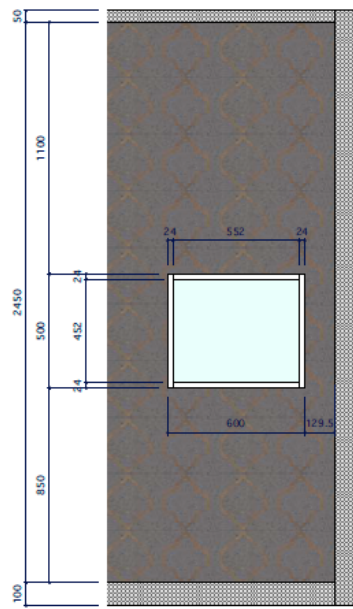

[断面図]

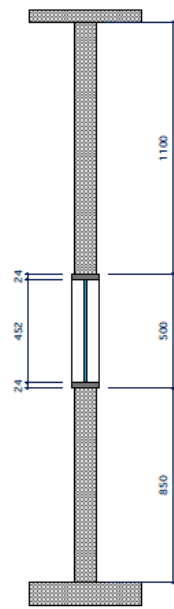

[断面詳細図]
S=1/10

